

Article number: 2310308331ESD

Description: E+G Antistatic base for levelling elements  
LV.A-80-14-AS-M12x98-ESD-C

## Measures

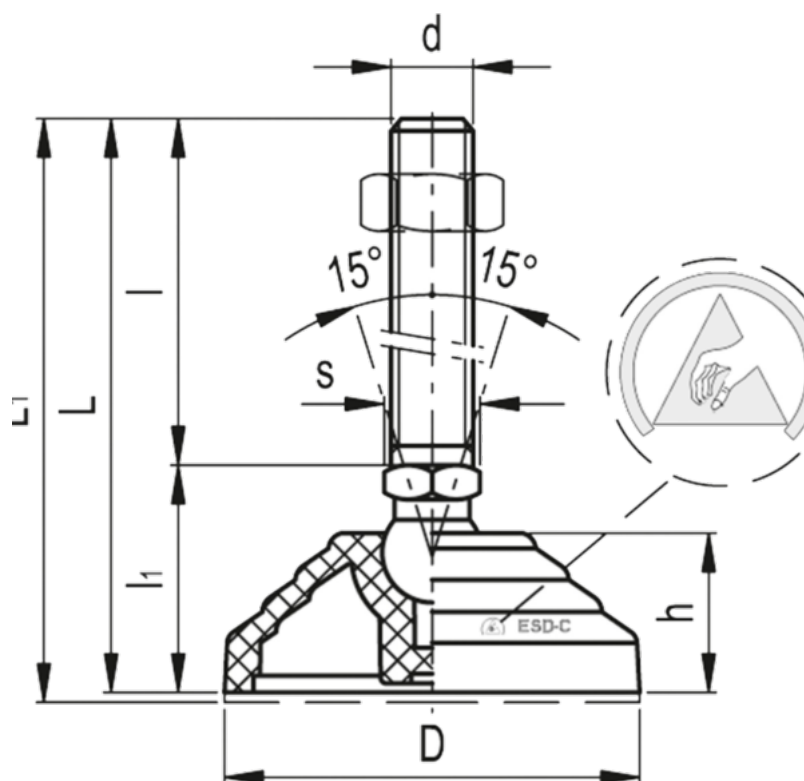

|              |       |               |         |
|--------------|-------|---------------|---------|
| Articulation | = 14  | Max load      | = 16000 |
| D            | = 80  | s             | = 14    |
| d            | = M12 | Weight in (g) | = 166   |
| h            | = 24  |               |         |
| l            | = 98  |               |         |
| l1           | = 33  |               |         |
| L            | = 131 |               |         |
| L1           | = 134 |               |         |